



ASCLASS

ASCLASS CERRAHİ ALETLER İMALAT SAN. VE TİC. LTD.ŞTİ

📍 Çatalarmut Mahallesi Sezgin Sokak No:7 Kat:1/2/3 İlkadım/SAMSUN

📱 asclasscerrahialetler.ve.medya 🌐 Asclass cerrahi aletler 🌐 www.asclassgrup.com 📧 info@asclassgrup.com - asclassmedya@gmail.com

ÜRÜN GRUPLARIMIZ

- » Genel Cerrahi
- » Beyin Cerrahi
- » Ortopedi Cerrahi
- » Göz Cerrahi
- » Kulak Burun Boğaz
- » Jinekoloji
- » Üroloji
- » Kalp Damar
- » Üniversal Ekartör Setleri
- » Laparoskopik Ekartör Setleri
- » Laparoskopik El Aletleri
- » Steril Konteynir Sistem

45-





45-100
Approximator

Derin aralıkta mikro damar anastomileri için.

- Güvenli ve dikkatli şekilde damar kavrama.
- Tırtıklı yüzeyli bleydler.
- El ile basınç ayarı yapabilmeye özelliği.
- Mesafeyi el ile yakınlştırma ve uzaklaştırma.

For micro vessel anastomosis

- Safe and careful gripping of vessel.
- Blades with serrated blade surface
- The ability to manually set the pressure distance, in and out manually.



BIEMER
45-101

Derin aralıkta mikro damar anastomileri için.

- Güvenli ve dikkatli şekilde damar kavrama.
- Tırtıklı yüzeyli bleydler.

For micro vessel anastomosis

- Safe and careful gripping of vessel.
- Blades with serrated blade surface
-



BIEMER
45-102
Komple Aproksimatör,
Approximator, complete

Sinir anastomilerine güvenli adaptasyon

- Sinir merkezinin, güçlü patolojik değişiklikleri önleyen hassas iğneler ile delinmesi
-
-

Safe adaptation of nerve anastomoses

- Piercing the nerve center with fine needles that prevents strong pathological changes
-



Geçici damar tıkkama için:

Güvenli ve dikkatli şekilde damar kavrama

Sabitlenmiş baskı mesafeli, tırtıklı yüzeyli bleydler

Kapama kuvveti klipsin ağızlarının 1/3 mesafesinde 1 mm aralık durumunda ölçülür.

For temporary occlusion :

Safe and careful gripping of vessel

Blades with serrated surface and rigidly fixed pressure feature

Closing force is measured at 1/3 of the blades a 1 mm opening



BIEMER

45-103

Çene uzunluğu/Lenght of jaws 6 mm

Açıklık/Opening 4 mm

Kapanma kuvveti/Closing force 30-40 gr. (0.29 - 0.39 N)

45-104

Çene Uzunluğu/Lenght of jaws 9 mm

Açıklık/Opening 5 mm

Kapanma kuvveti/Closing force 30-40 gr. (0.29 - 0.39 N)

BIEMER

45-105

Çene uzunluğu/Lenght of jaws 9 mm

Açıklık/Opening 5 mm

Kapanma kuvveti/Closing force 20-25 gr. (0.20 - 0.25 N)

for vessel Ø 0.5 - 2.0 mm.



MEHDORN

45-106

Çene uzunluğu/Lenght of jaws 1 mm

Açıklık/Opening 4 mm

Kapanma kuvveti/Closing force 10-15 gr. (0.10 - 0.15 N)

MEHDORN

45-107

Çene uzunluğu/Lenght of jaws 1.4 mm

Açıklık/Opening 4 mm

Kapanma kuvveti/Closing force 15-20 gr. (0.15 - 0.20 N)

MEHDORN

45-108

Çene uzunluğu/Lenght of jaws 1 mm

Açıklık/Opening 6 mm

Kapanma kuvveti/Closing force 10-15 gr. (0.10 - 0.15 N)

MEHDORN

45-109

Çene uzunluğu/Lenght of jaws 1.4 mm

Açıklık/Opening 6 mm

Kapanma kuvveti/Closing force 15-20 gr. (0.15 - 0.20 N)

for vessel Ø 0.5 - 2.0 mm.



Mikro damar anastomileri için:
Güvenli ve dikkatli şekilde damar kavrama.
Sabitlenmiş baskı mesafeli, tırtıllı yüzeyli bleydler.
Klipsler arası mesafe ayarlanabilir.
Bükerek otomatik sabitleme.

For micro vessel anastomosis:
Safe and careful gripping of vessel.
Blades with serrated surface and rigidly fixed pressure feature.
Adjustable distance between clips.
Automatic fixation by tilling



BIEMER-MÜLLER
45-110
Çene uzunluğu/Lenght of jaws.6 mm
Açıklık/Opening 4 mm
Kapanma kuvveti/Closing force 30-40 gr.



BIEMER-MÜLLER
45-111
Çene uzunluğu/Lenght of jaws.4.5 mm
Açıklık/Opening 3 mm
Kapanma kuvveti/Closing force 25-30 gr.



BIEMER-MÜLLER
45-112
Çene uzunluğu/Lenght of jaws.9 mm
Açıklık/Opening 5 mm
Kapanma kuvveti/Closing force 25-30 gr.



BIEMER-MÜLLER
45-113
Çene uzunluğu/Lenght of jaws.9 mm
Açıklık/Opening 5 mm
Kapanma kuvveti/Closing force 25-30 gr.

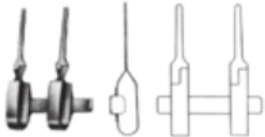

BIEMER-MÜLLER
45-114
Çene uzunluğu/Lenght of jaws.9 mm
Açıklık/Opening 5 mm
Kapanma kuvveti/Closing force 25-30 gr.

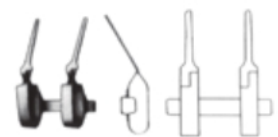

BIEMER-MÜLLER
45-115
Çene uzunluğu/Lenght of jaws.9 mm
Açıklık/Opening 5 mm
Kapanma kuvveti/Closing force 25-30 gr.

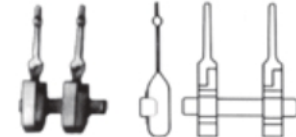

MÜLLER
45-116
Kapanma kuvveti/Closing force. 25-30 gr.

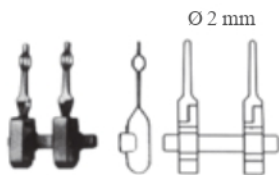

MÜLLER
45-117
Kapanma kuvveti/Closing force. 25-30 gr.

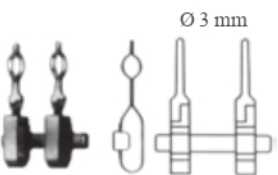

MÜLLER
45-118
Kapanma kuvveti/Closing force. 25-30 gr.

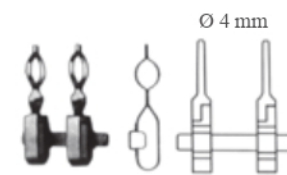

MÜLLER
45-119
Kapanma kuvveti/Closing force. 25-30 gr.



Toplam boy
Total length

Ağız uzunluğu
Length of jaws

DIEFFENBACH

45-120	38 mm	12 mm
45-121	48 mm	16 mm



Toplam boy
Total length

Ağız uzunluğu
Length of jaws

DIEFFENBACH

45-122	38 mm	12 mm
45-123	48 mm	16 mm



Toplam boy
Total length

Ağız uzunluğu
Length of jaws

DIEFFENBACH

45-124	58 mm	16 mm
---------------	-------	-------



Toplam boy
Total length

Ağız uzunluğu
Length of jaws

DIEFFENBACH

45-125	58 mm	16 mm
---------------	-------	-------



Toplam boy
Total length

Ağız uzunluğu
Length of jaws

DE BAKEY-HESS

45-126	34 mm	20mm
45-127	43 mm	30mm



Toplam boy
Total length

Ağız uzunluğu
Length of jaws

JOHNS-HOPKINS

45-128	38 mm	12 mm
45-129	48 mm	17 mm
45-130	56 mm	25 mm
45-131	63 mm	30 mm
45-132	70 mm	33 mm
45-133	80 mm	42 mm
45-134	91 mm	52 mm



JOHNS-HOPKINS

45-135

Buldog klemplerin takılması ve çıkarılması için pens



V1

BIEMER
45-136
Kilitsiz/Without lock



V1

BIEMER
45-137
Kilitli/With lock



V1



V1

BIEMER
45-138
Uygulama pensetleri, damar klipsleri,
BIEMER-MÜLLER ve MÜLLER aproksi
matör.
Applying forceps for BIEMER
vessel approximator
14.5 cm



V1

MEHDORN
45-139
Uygulama pensetleri, MEHDORN
damar klipsleri
Applying forceps for MEHDORN
vessel clips
15 cm

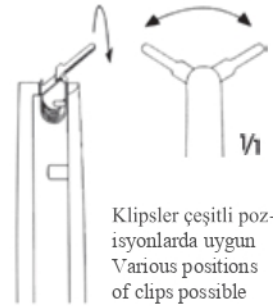

Klipsler çeşitli poz-
isyonlarda uygun
Various positions
of clips possible

BIEMER
45-140 - 45-141
BIEMER damar klipsleri ve BIEMER-MÜLLER ve
MÜLLER yaklaştırıcılar için başvuru pensleri
Applying forceps for BIEMER vessel clips and
BIEMER-MÜLLER and MÜLLER approximators
14 cm

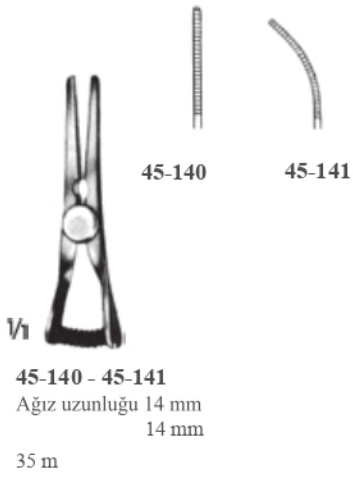

Length of jaws 19 mm

Length of jaws 19 mm

Length of jaws



De Bakey Diş



Toothing De BAkey



Toplam boy
Total length

Ağız uzunluğu
Length of jaws

Toplam boy
Total length

Ağız uzunluğu
Length of jaws

DE BAKEY

45-147	8.0 cm	25 mm
45-148	9.0 cm	35 mm
45-149	10.5 cm	50 mm
45-150	12.4 cm	68 mm

DE BAKEY

45-151	7.8 cm	23 mm
45-152	8.6 cm	31 mm
45-153	9.7 cm	42 mm
45-154	11.4 cm	58 mm



1/2

DE BAKEY
45-155

Ağız uzunluğu 27 mm
Length of jaws 27 mm
5 cm



75°

1/2

GLOVER
45-156

Ağız uzunluğu 35 mm
Length of jaws 35 mm
5.2 cm



Toplam boy
Total length

Ağız uzunluğu
Length of jaws

GLOVER

45-157	33 mm
45-158	50 mm
45-159	69 mm



Toplam boy
Total length

Ağız uzunluğu
Length of jaws

GLOVER

45-160	6.5 cm	33 mm
45-161	9.1 cm	50 mm
45-162	11 cm	69 mm



DE BAKEY
45-163

Ağız uzunluğu 27 mm
Length of jaws 27 mm
4.8 cm



21 cm

1/1

1/2

DE BAKEY
45-164

Ağız uzunluğu 38 mm
Length of jaws 38 mm
7.3 cm



21 cm

1/1

1/2

DE BAKEY
45-165

Ağız uzunluğu 63 mm
Length of jaws 63 mm
9.9 cm

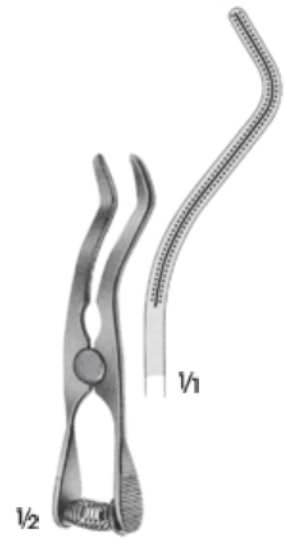

1/2

DE BAKEY
45-166

Ağız uzunluğu 54 mm
Length of jaws 54 mm
9.5 cm

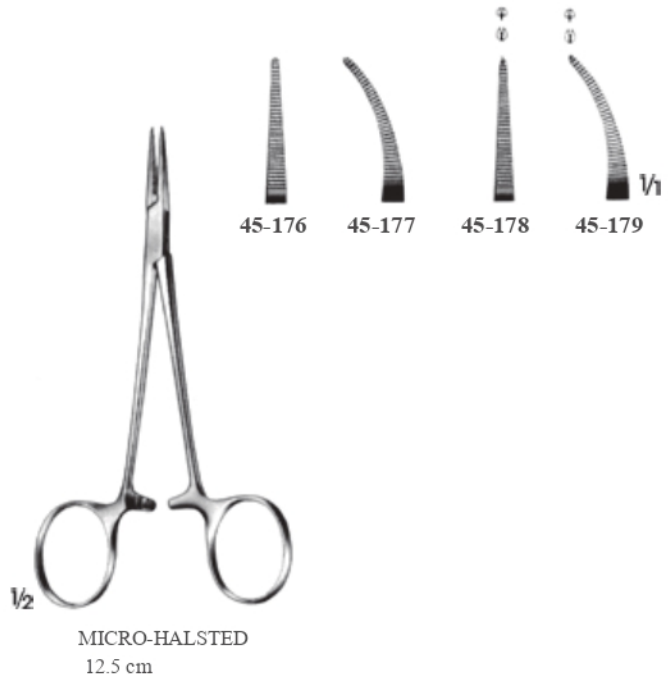
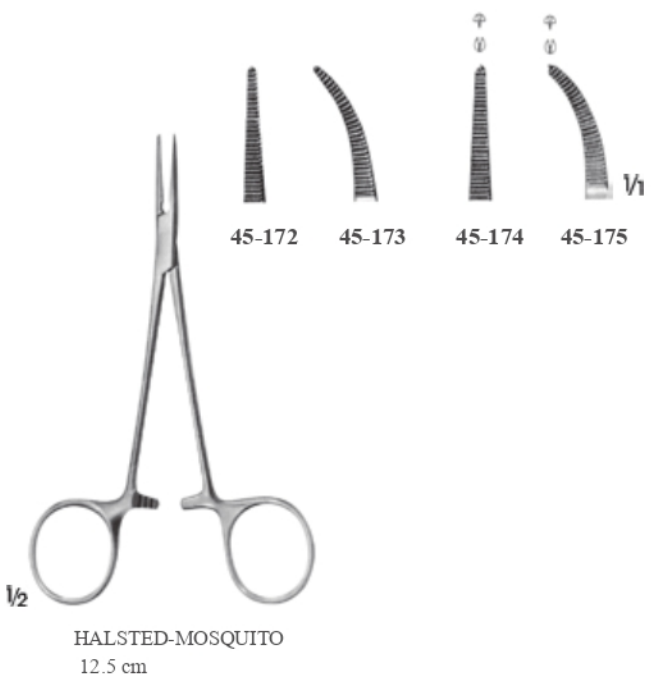
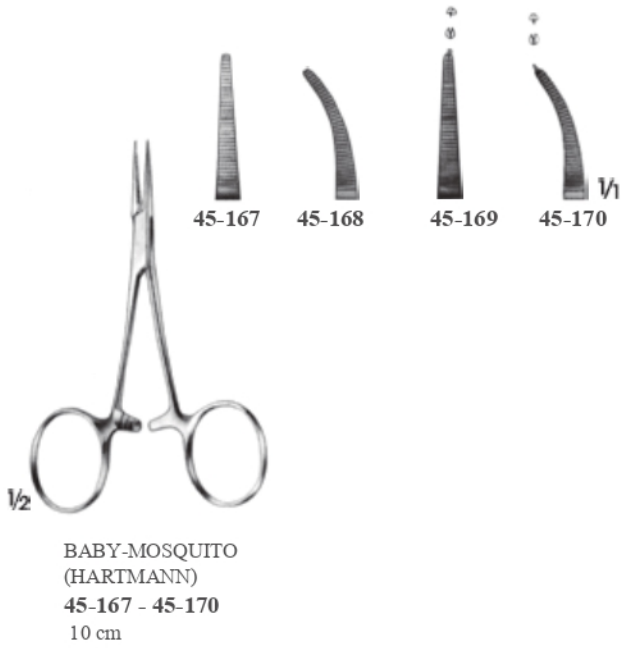



$\frac{1}{2}$
PROVIDENCE-HOSPITAL
45-180 - 45-181
14 cm



$\frac{1}{2}$
KELLY
45-182 - 45-183
14 cm

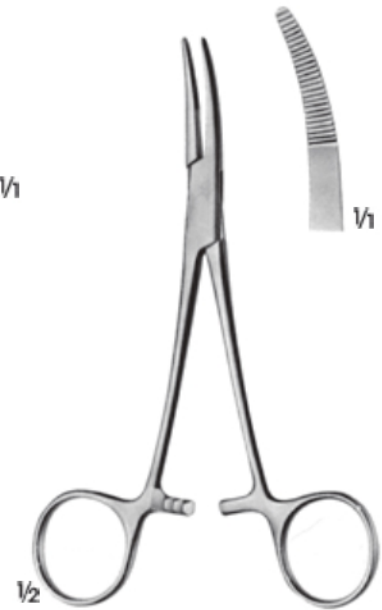

$\frac{1}{2}$
MOYNIHAN
45-184
Yana eğimli/Curved to side
15 cm

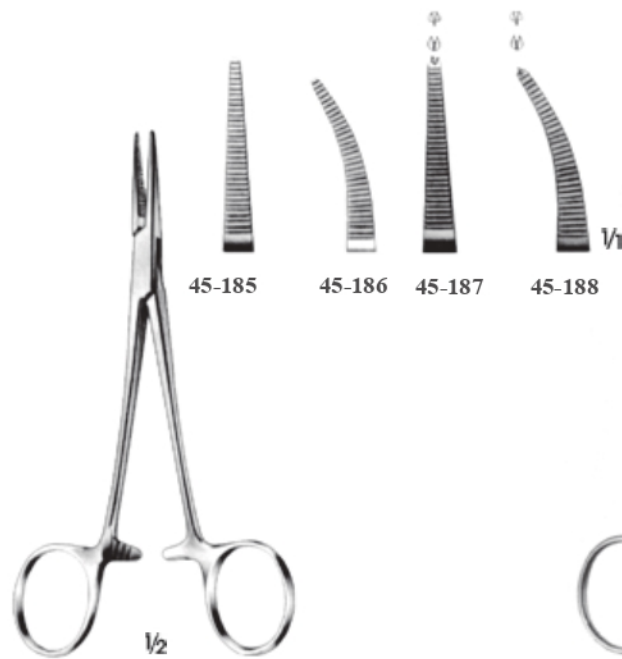

$\frac{1}{2}$
BABY-CRILE
14 cm

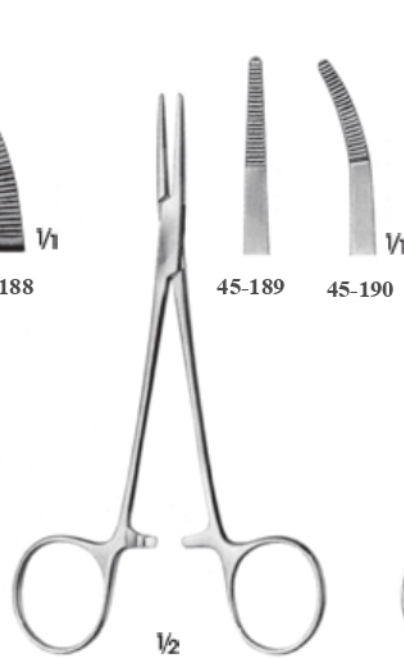

$\frac{1}{2}$
CAIRNS
15 cm

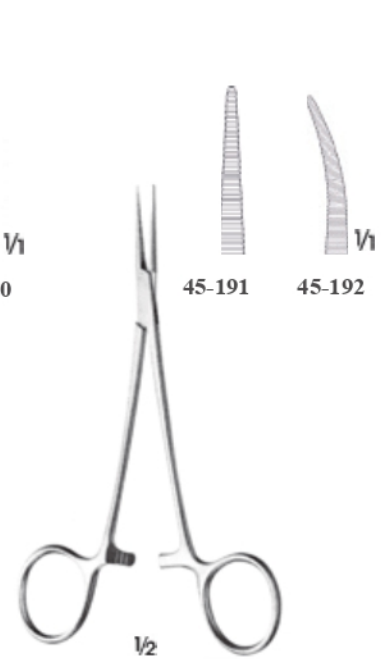

$\frac{1}{2}$
JACOBSON
12.5 cm

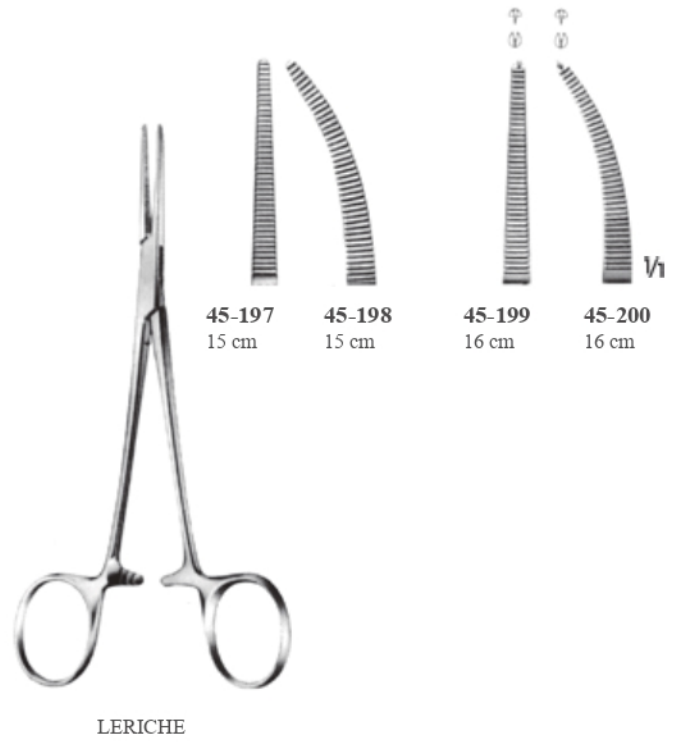
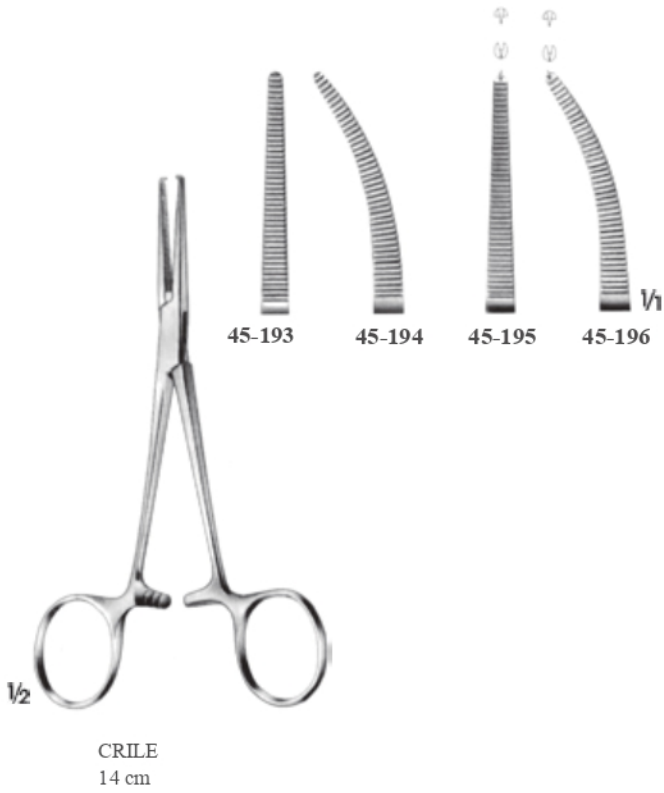



PEAN

45-204
13 cm

45-205
14 cm

45-206
13 cm

45-207
14 cm



PEAN

45-208
13 cm

45-209
14 cm

45-210
14 cm



SPENCER - WELLS

45-211
13 cm

45-212
15 cm

45-213
17.5 cm

45-214
20 cm

45-215
13 cm

45-216
15 cm

45-217
17.5 cm

45-218
20 cm

45-219
23 cm

Ince model/Slender type



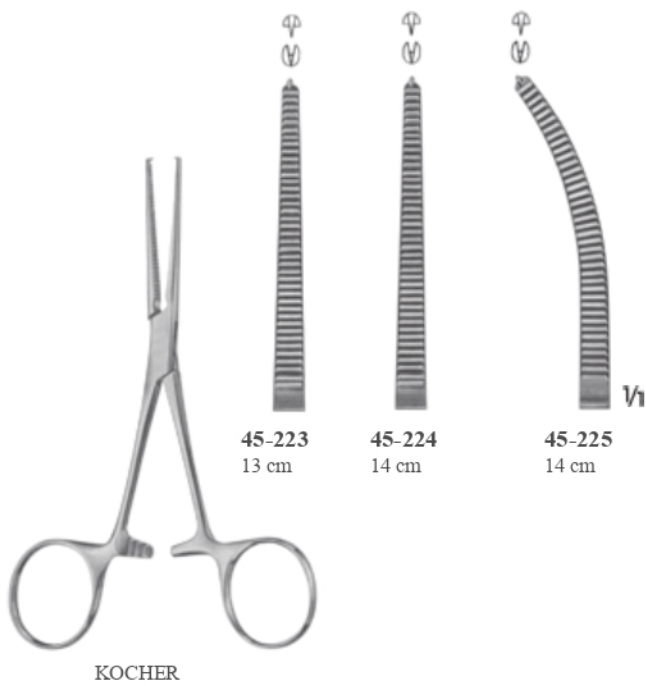
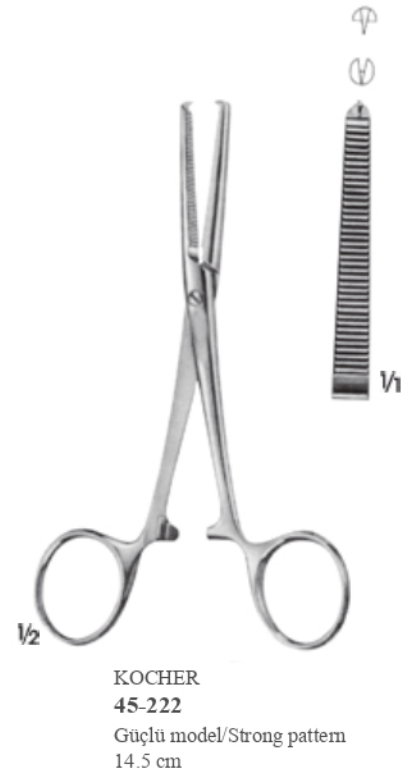



45-228
14 cm

COLLER



45-229
16.5 cm



45-230
14 cm



45-231
16.5 cm



1/2

RANKIN
16 cm



45-232



45-233

1/1



1/2

CRILE
16 cm



45-234



45-235



45-236



45-237

1/1

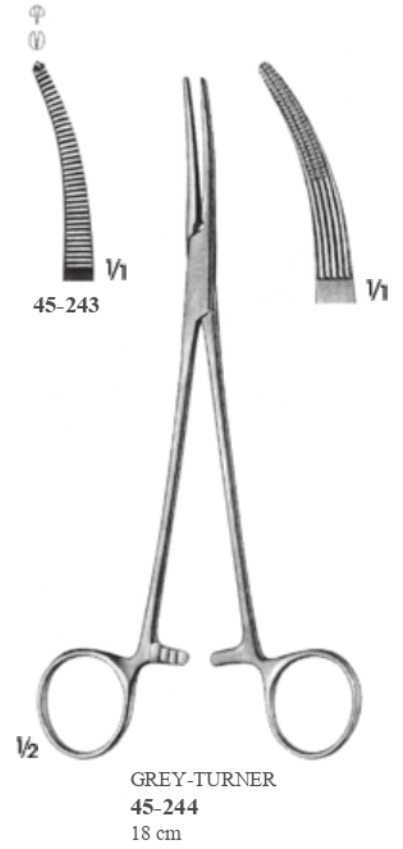
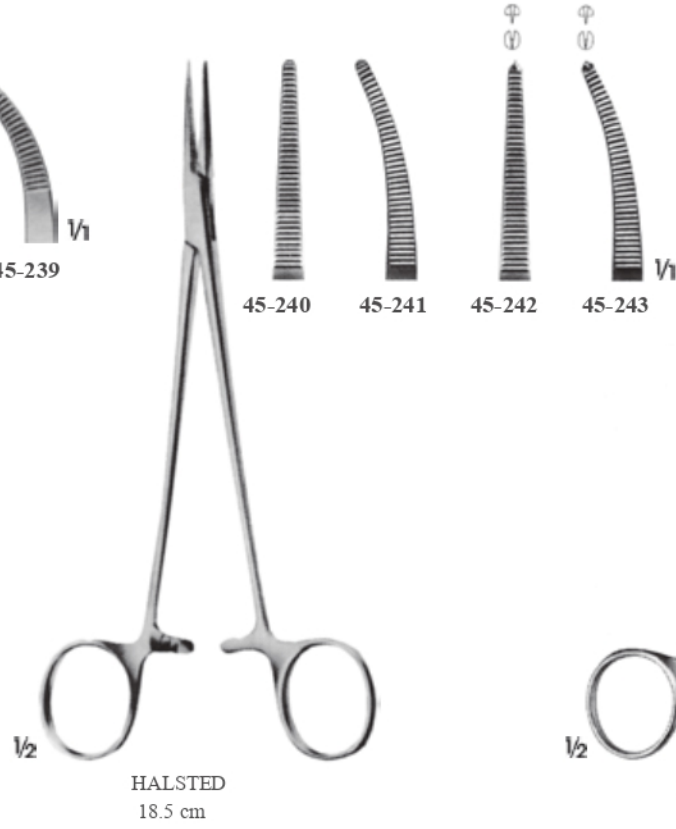



FRASER-KELLY(CRILE)
45-249
18 cm



DUNHILL
45-250
19 cm

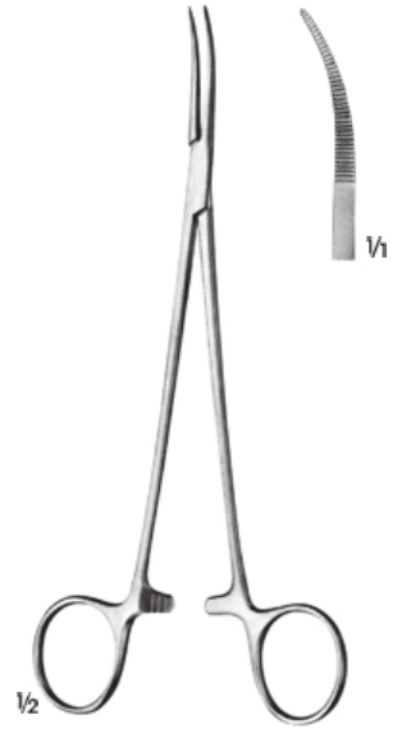

JACOBSON
45-251
19 cm

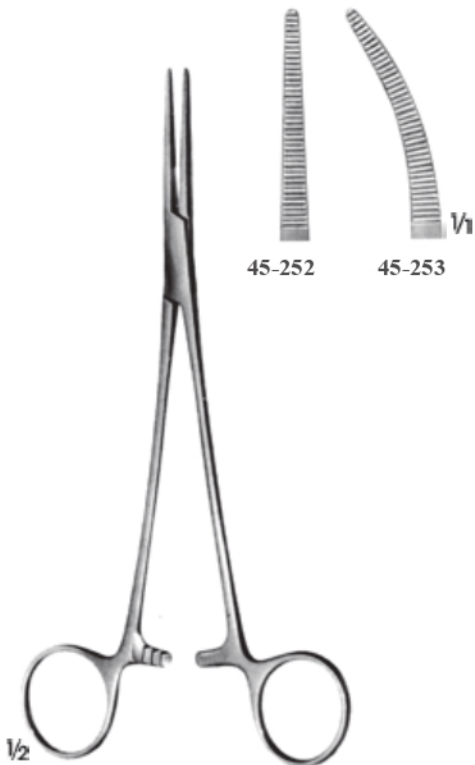

BIRKETT
18.5 cm

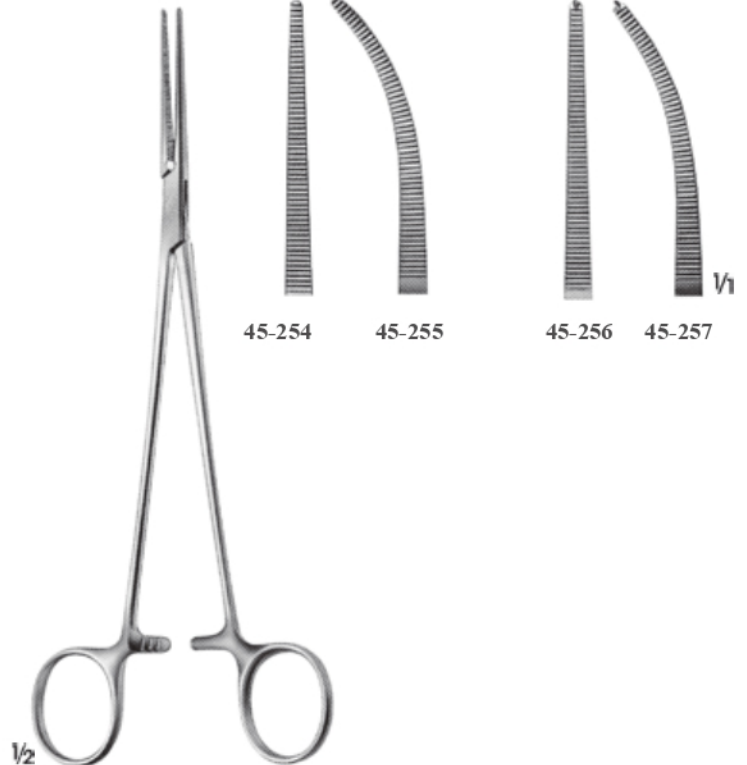

HALSTED-MOSQUITUO
20 cm





T45-258
20 cm



45-259
20 cm



45-260
19.5 cm



45-261
20 cm



45-262
20 cm

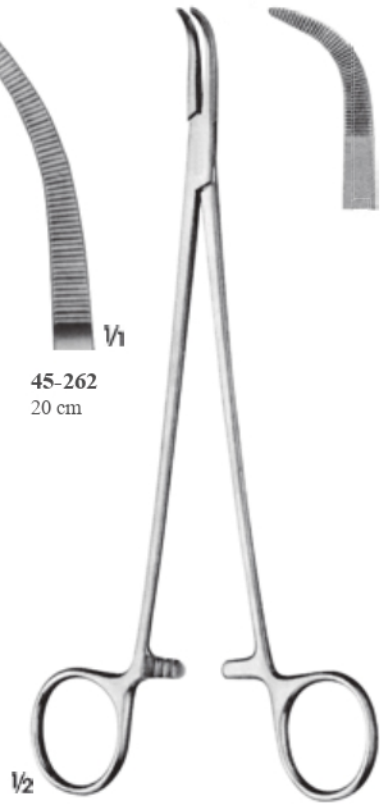

ADSON
45-263
21.5 cm



BENGOLA
24.5 cm



45-264



45-265



45-266



45-267

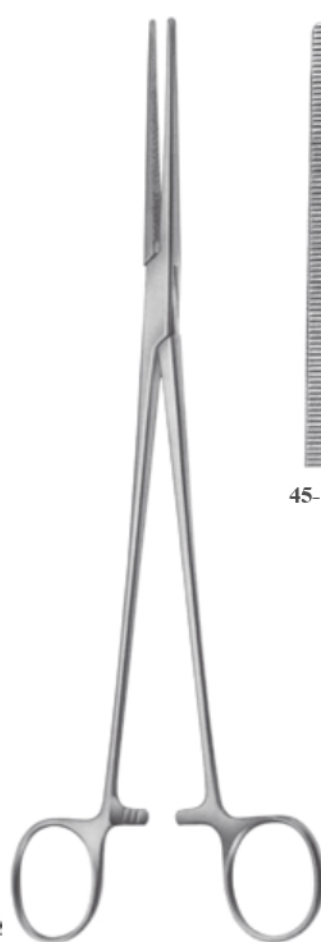

SAROT
24 cm



45-268



45-269



45-270
16 cm



45-271
18.5 cm



45-272
20 cm



45-273
22.5 cm



45-274
24 cm



45-275
35 cm



V1



45-276
16 cm



45-277
18.5 cm



45-278
20 cm



45-279
22.5 cm



45-280
24 cm



45-281
35 cm



V1

ROCHESTER - PEAN





BRIDGE
T15-198 - T15-199
27.5 cm



CRAFOORD
45-284
24.5 cm

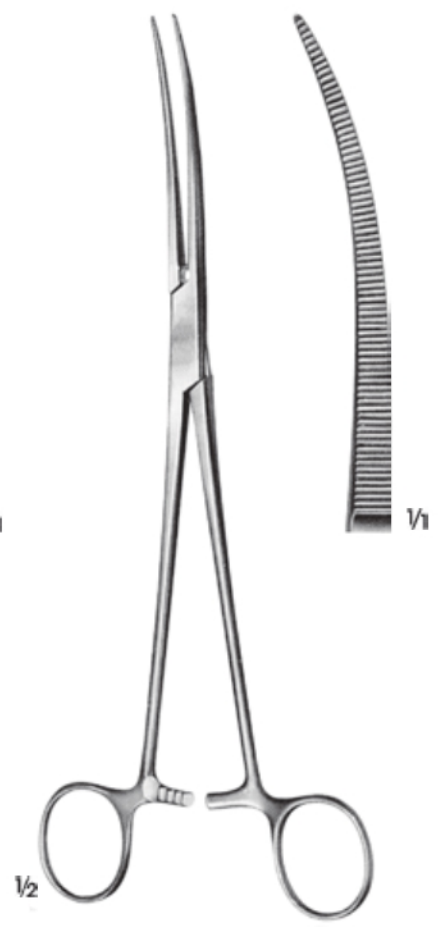

CRAFOORD, MOD.
45-285
24 cm





PEAN



45-286
24 cm



45-287
26 cm



45-288
28 cm



45-289
24 cm



45-290
26 cm



45-291
28 cm

V1

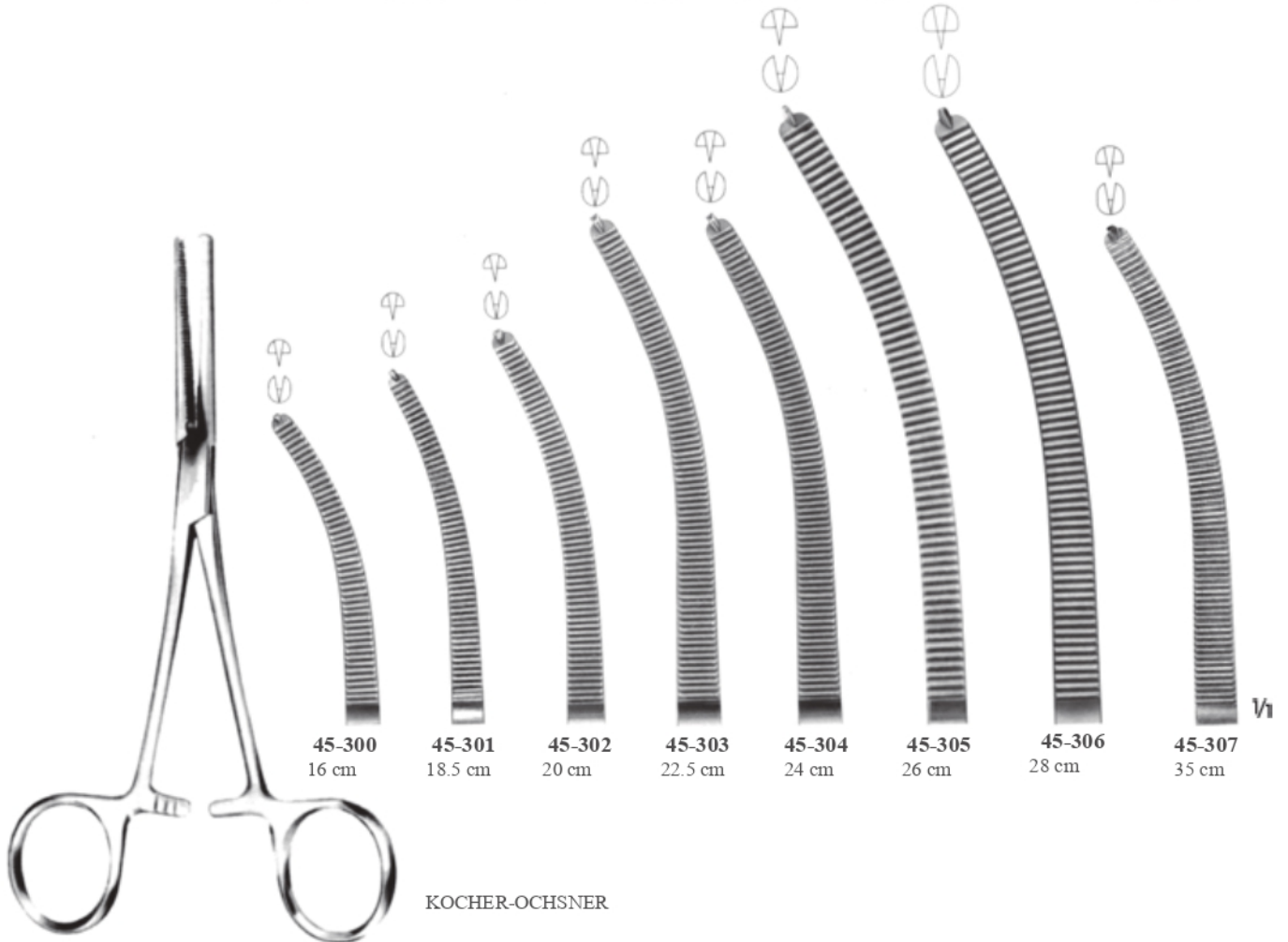
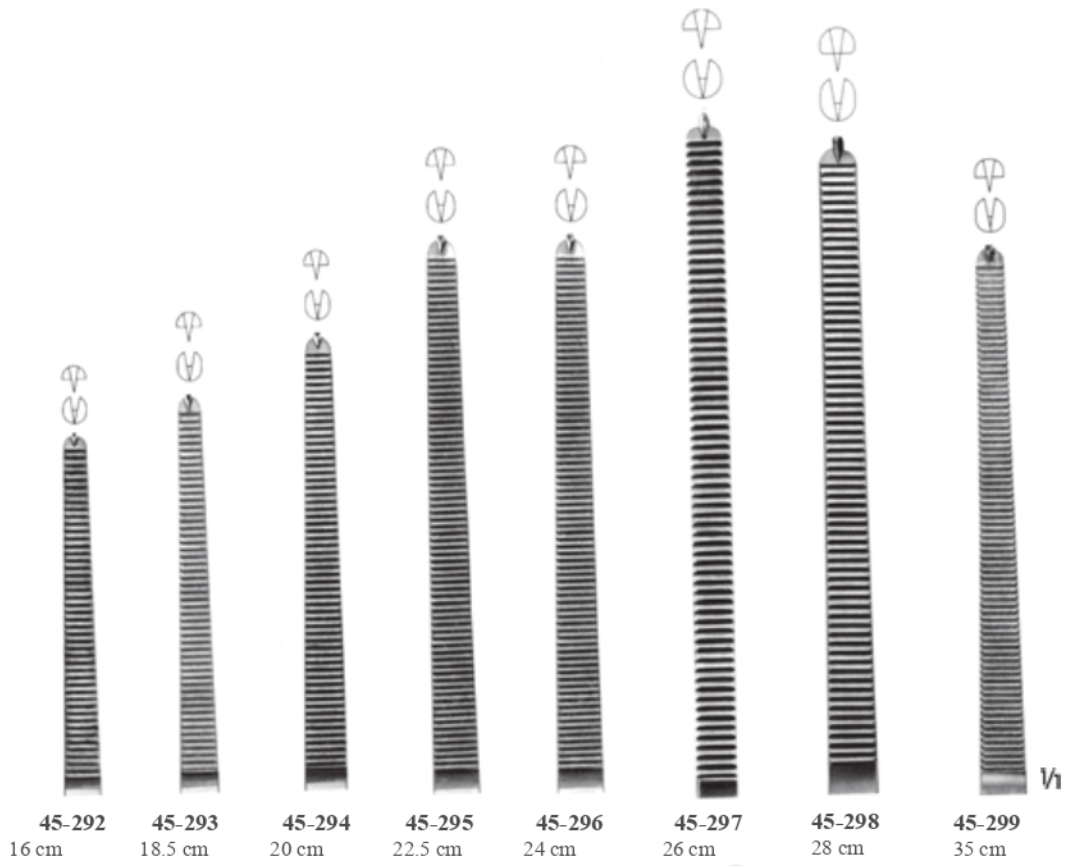

KOCHER-OCHSNER



ROCHESTER-CARMALT

45-308
16 cm

45-309
20 cm

45-310
16 cm

45-311
20 cm

1/2



FICKLING
18 cm

45-312

45-313
1x2 diş
1x2 teeth

1/2



MOYNIHAN

45-314
23 cm

45-315
24 cm

1/2



ROBERTS
25 cm

45-316

45-317

1/2



MICRO-ADSON
45-318
Diseksiyon pensi
Dissecting forcep
14 cm



BABY-ADSON
Diseksiyon pensleri
Dissecting forceps



45-320
18 cm

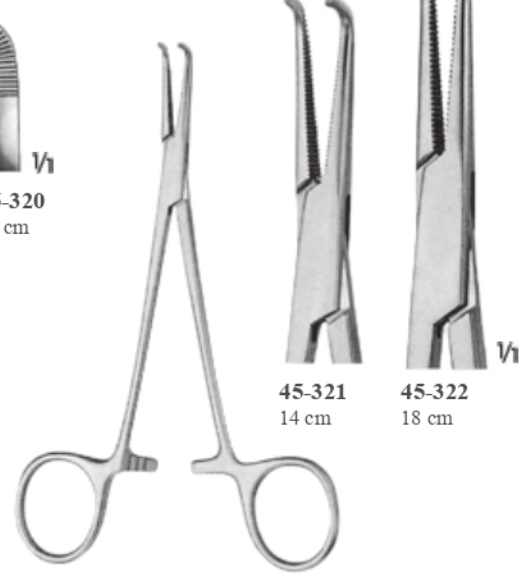

45-321
14 cm



45-322
18 cm

Diseksiyon pensleri
Dissecting forceps



45-323
14 cm

45-324
18 cm

BABY-MIXTER
Diseksiyon pensleri
Dissecting forceps



BABY-OVERHOLT
45-325
Diseksiyon pensi
Dissecting forcep
13.5 cm



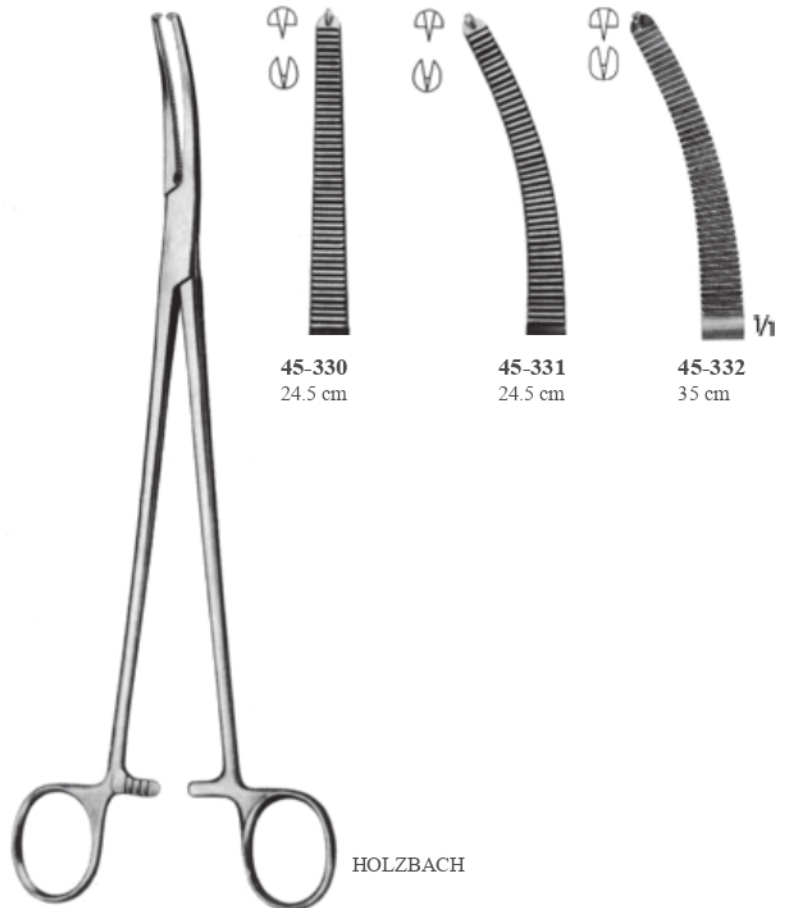
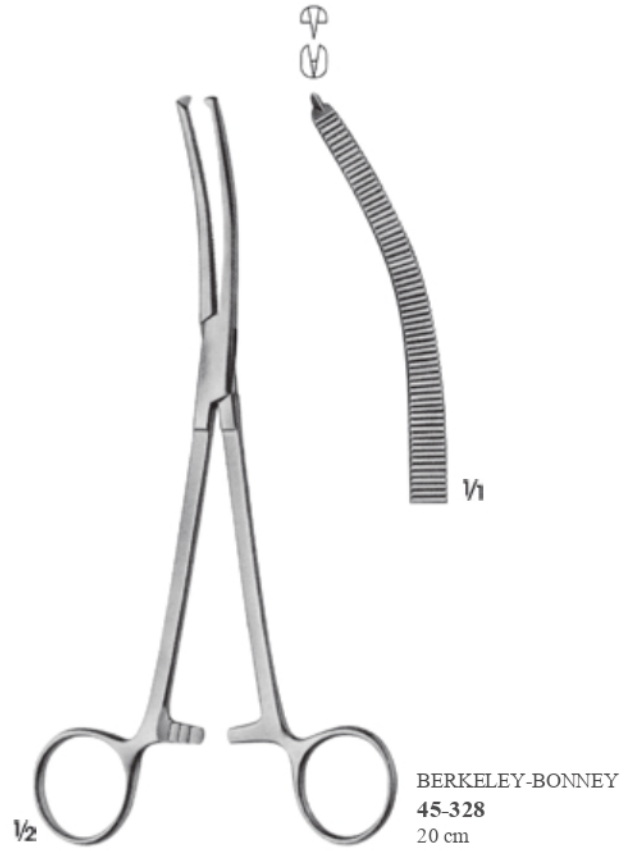
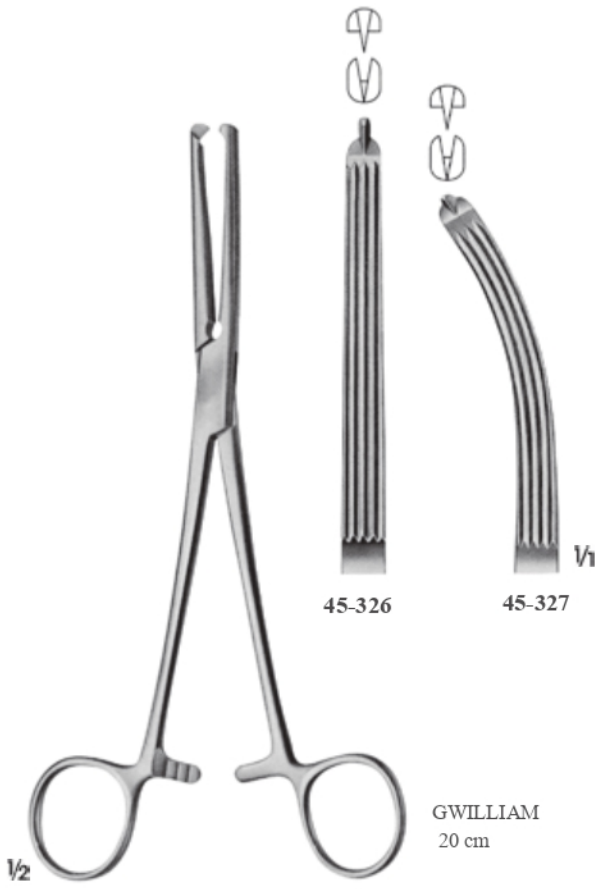

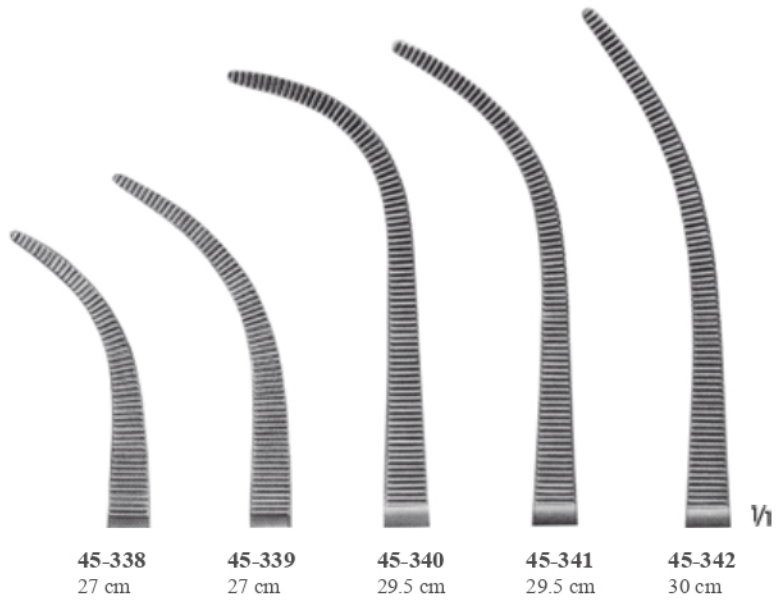
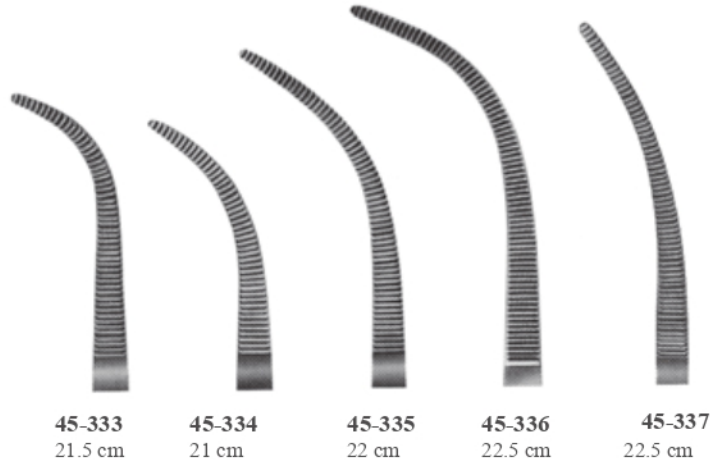

OVERHOLT
Hassas model/Delicate pattern



45-343
15 cm



45-344
18 cm



45-345
20 cm



45-346
23 cm



45-347
25.5 cm

O'SHAUGHNESSY
45-343 - 45-347

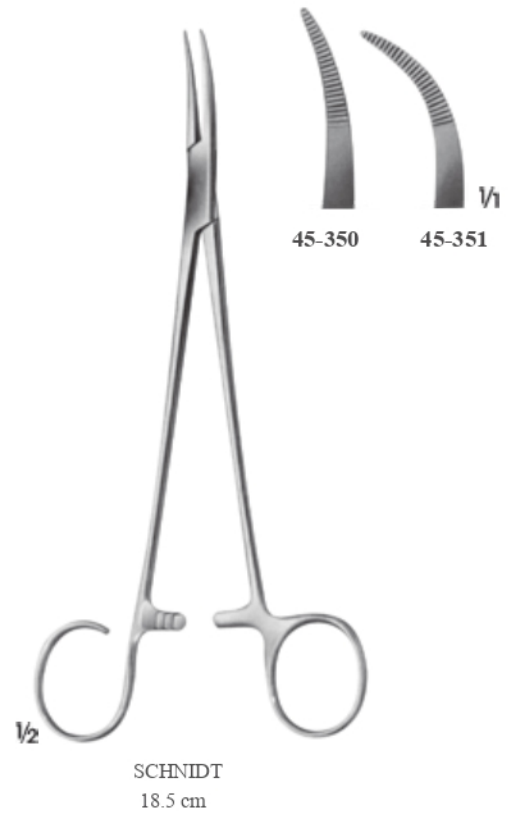

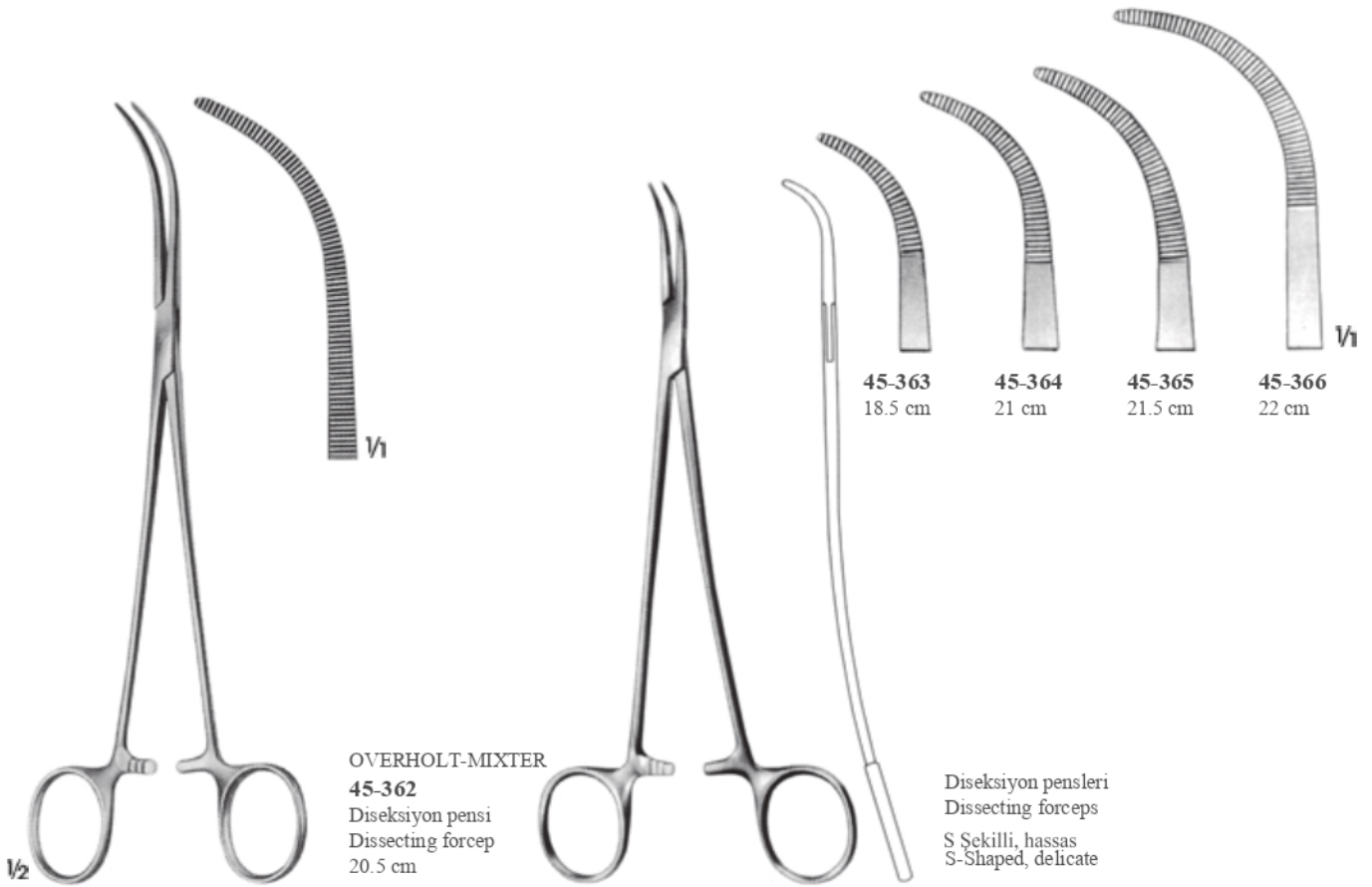
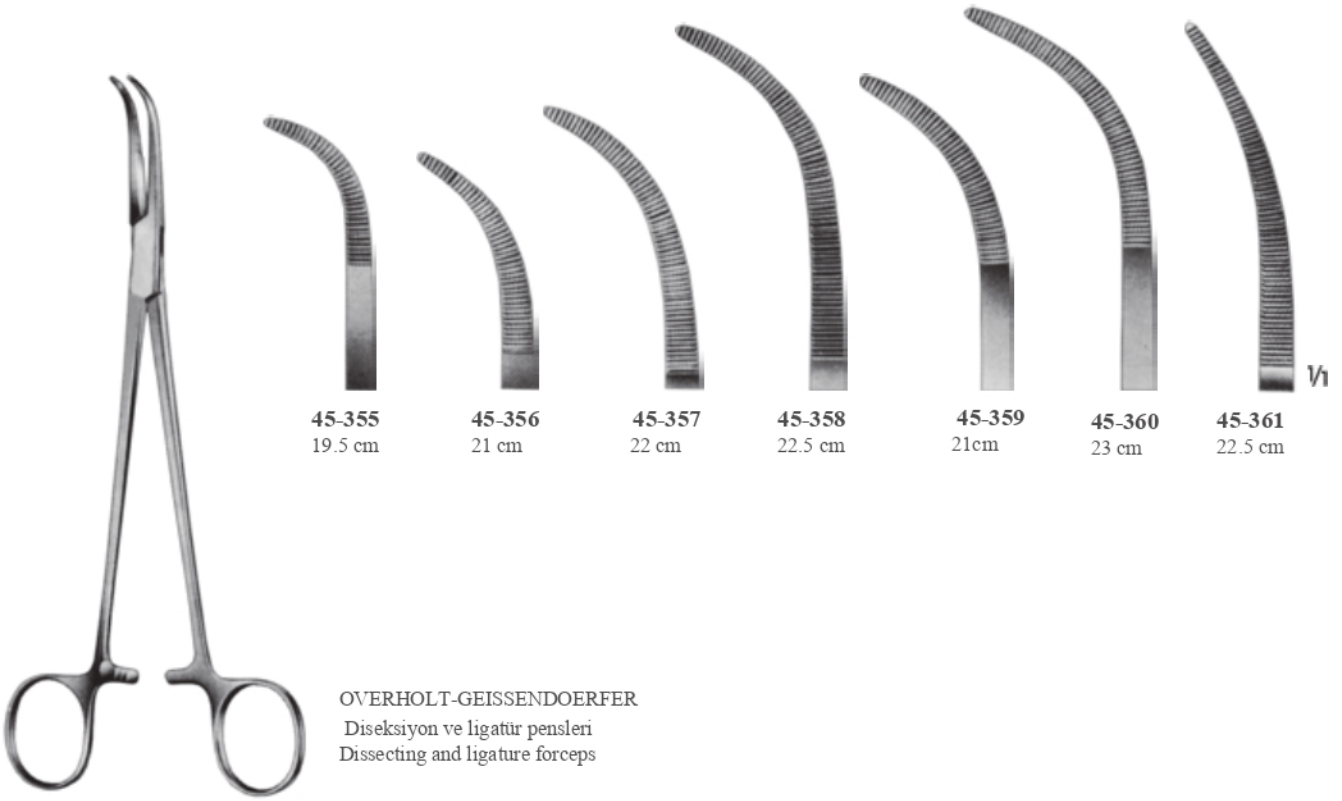



GEMINI



45-367
13 cm



45-368
18 cm



45-369
20 cm



45-370
23 cm

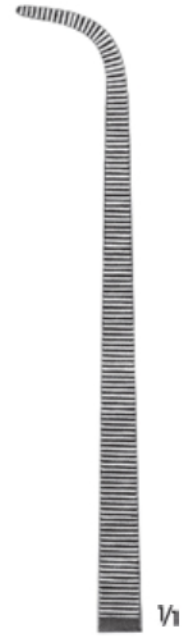

45-371
28 cm



OVERHOLT-GEISSENDOERFER



45-372
26 cm



45-373
27 cm



45-374
27.5 cm



45-375
27 cm



45-376
28 cm



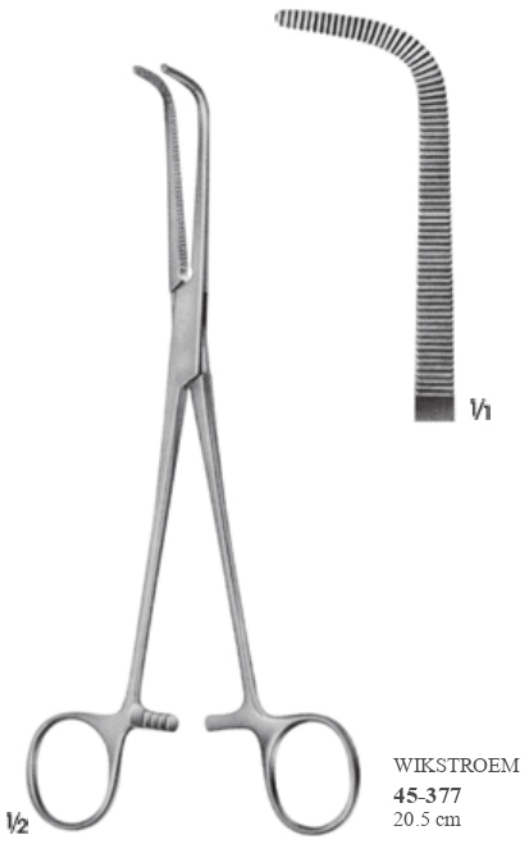



RUMEL
24 cm



45-381



45-382



45-383



45-384



45-385

V1



BARRE
28 cm



45-386
Çok hassas
Extra delicate



45-387
Hassas
Delicate

V1



KANTROWITZ



45-388
20 cm



45-389
24 cm



45-390
27.5 cm

V1



ZENKER



45-391
30 cm



45-392
29 cm



45-393
35 cm



45-394
35 cm



45-395
35 cm

V1





LAWRENCE
45-396
27 cm



MIXTER
45-397
23 cm



45-398
19.5 cm

PEAN



45-399
22 cm



45-400
23 cm

1/1



SAROT
45-401
25 cm



1/1



ROBERTS
45-402
22.5 cm



1/1

1/2

1/2



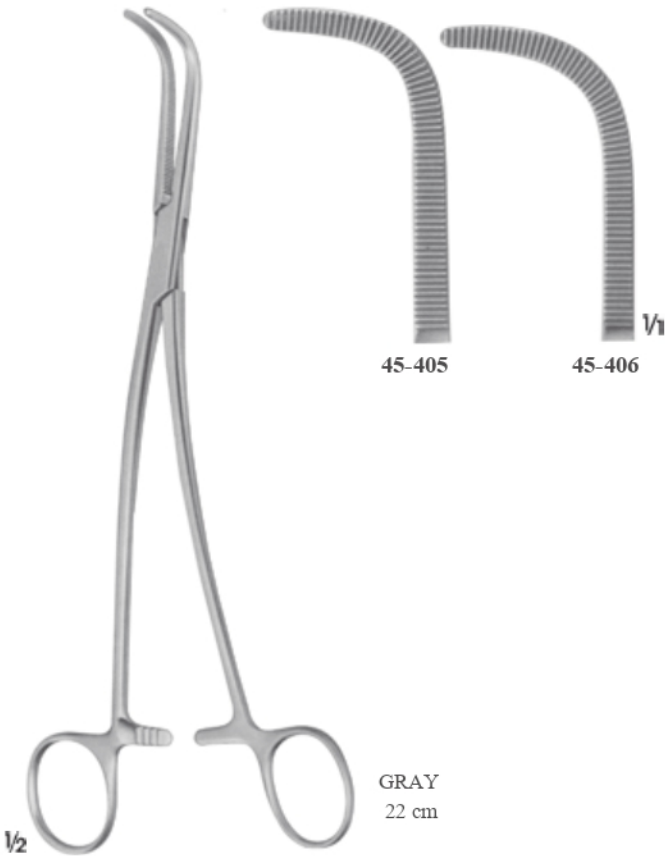
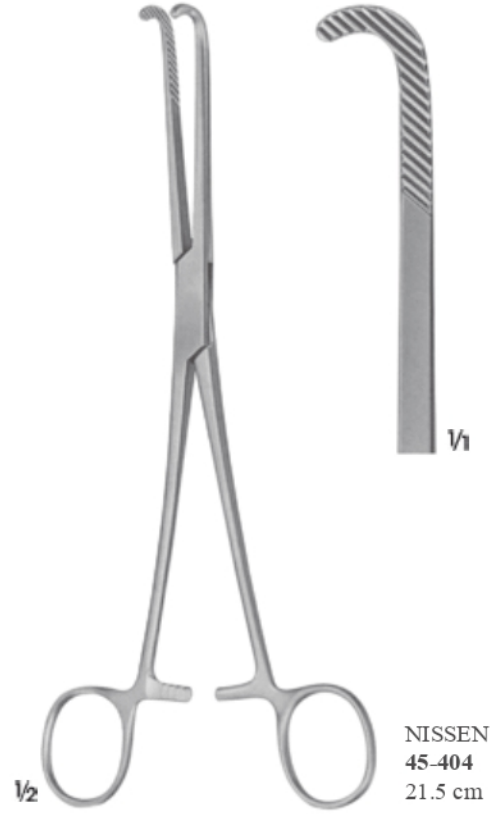



BABY-MIKULICZ
45-408
14 cm



MIKULICZ
45-409
18.5 cm



MIKULICZ
45-410 - 45-411



MIKULICZ
45-412
20.5 cm



MIKULICZ
45-413
20.5 cm

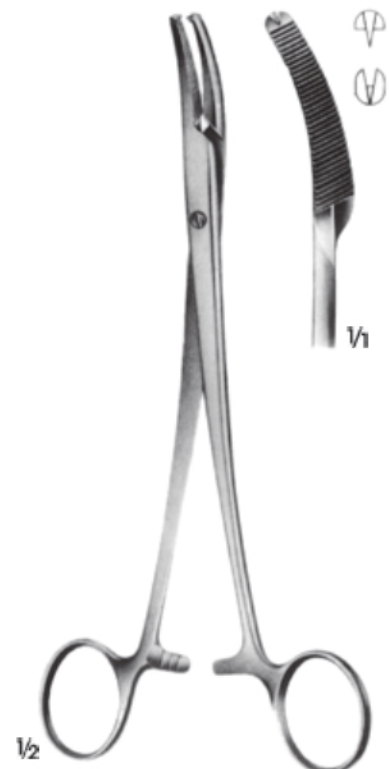

MIKULICZ
45-414
20 cm



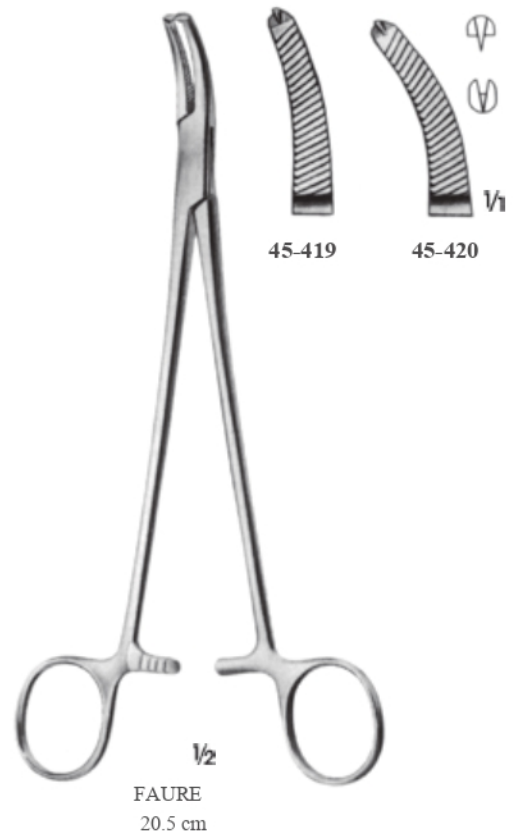
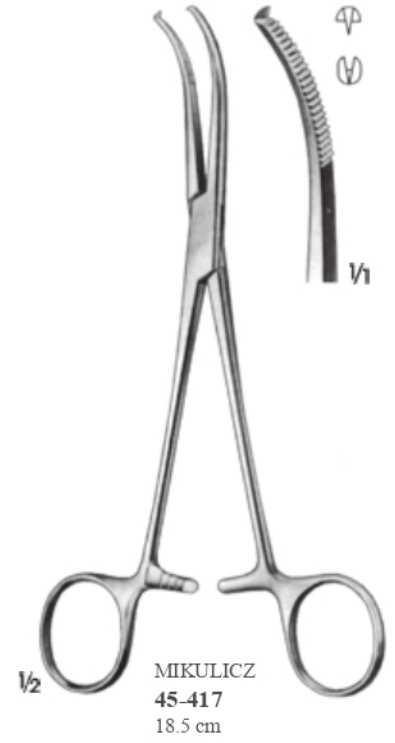

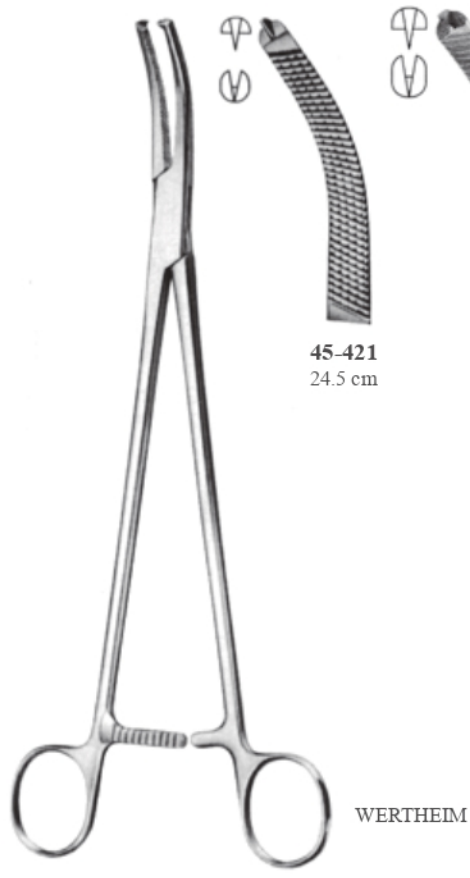

45-421
24.5 cm

45-422
35 cm

WERTHEIM

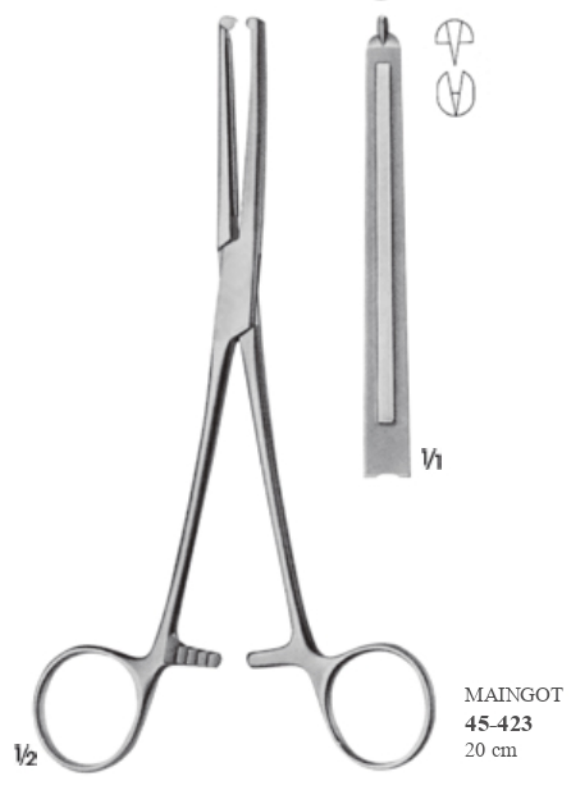

MAINGOT
45-423
20 cm



45-424
20.5 cm

45-425
25 cm

MAINGOT





LAHEY (SWEET) LAHEY
45-426 45-427
20 cm 22.5 cm

LAHEY



LAHEY (SWEET)
45-428
23 cm

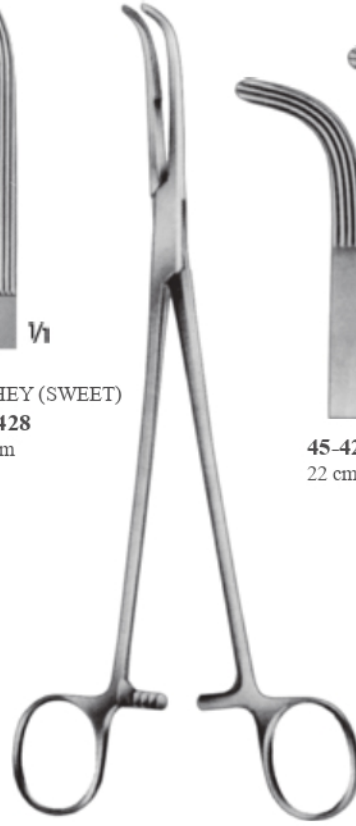

45-429
22 cm

MIXTER



45-430
25 cm

45-431
29 cm



1/2

LOWER
45-432
18 cm



45-433
23.5 cm

KEIBACK

Öne eğimli üreter kanalı
açma klempleri
Ureteral tunnel clamps
curved on flat

45-434
35 cm





BURKE

Parametrium pensi kısa ağız
Parametrium clamp, short jaw part



BURKE

Parametrium pensi uzun ağız
Parametrium clamp, long jaw part

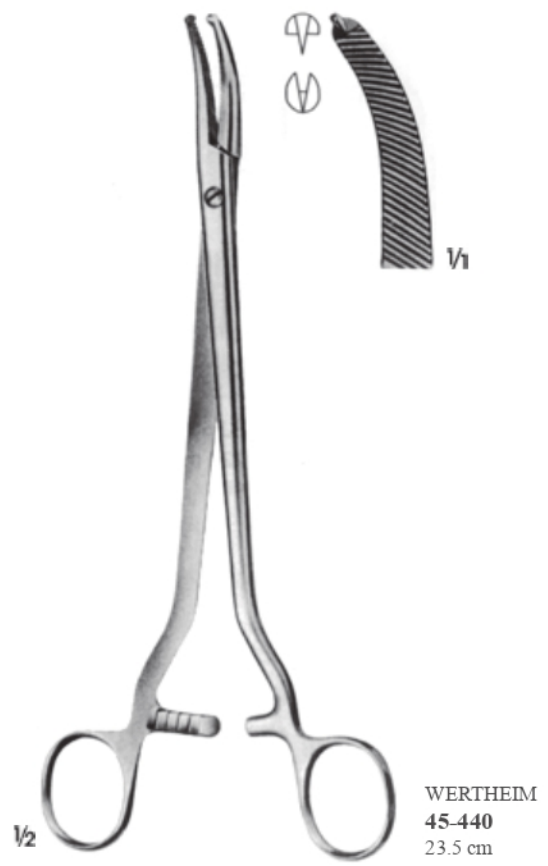



HEANEY

45-443
20.5 cm

45-444
24.5 cm

45-445
35 cm

1/1



1/2

HEANEY
45-446
19.5 cm



PHANEUF

45-447
21 cm

45-448
20.5 cm

1/1



WIENER MODELL

45-449
22 cm

45-450
24 cm

1/1

De Bakey Diş



Toothing De BAkey



45-451
25.5 cm

45-42
26.5 cm

45-453
27.5 cm

DICK



De Bakey Diş



Toothing De BAkey



KIEBACK



45-454
25 cm



45-455
35 cm



45-456
25 cm



45-457
35 cm

V1



WERTHEIM
45-458
25.5 cm



WERTHEIM
45-459
26 cm

De Bakey Diş



Toothing De BAkey



HEANEY

45-460
22.5 cm

45-461
22 cm

45-462
21.5 cm

45-463
20.5 cm



WERTHEIM

45-464
25 cm

45-465
24.5 cm

45-466
24 cm

45-467
22 cm



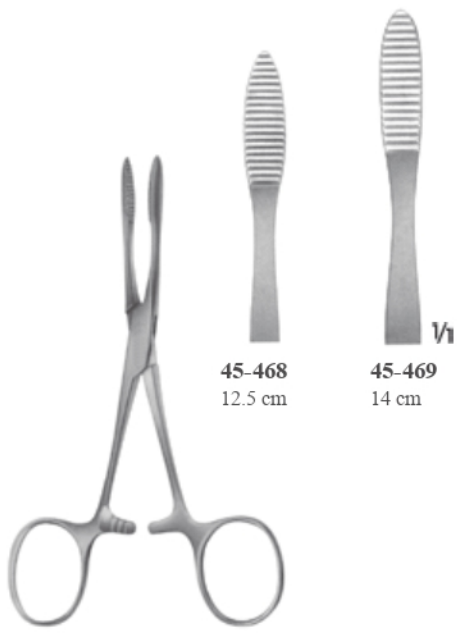

45-468
12.5 cm

45-469
14 cm

PEAN

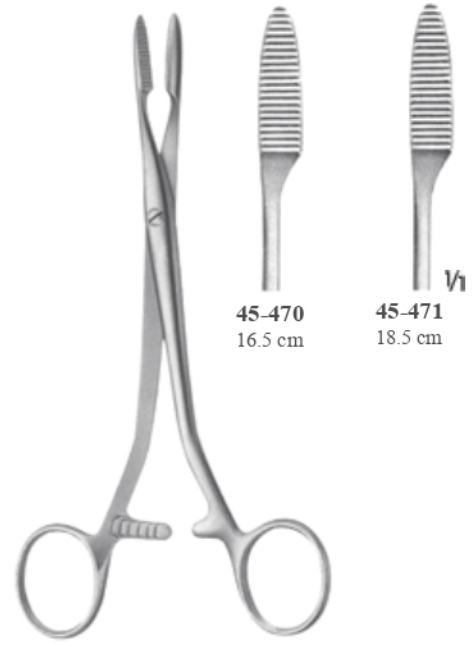

45-470
16.5 cm

45-471
18.5 cm

PEAN

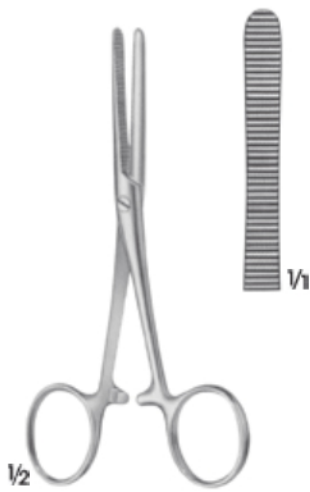

1/2

PEAN
45-472
12.5 cm

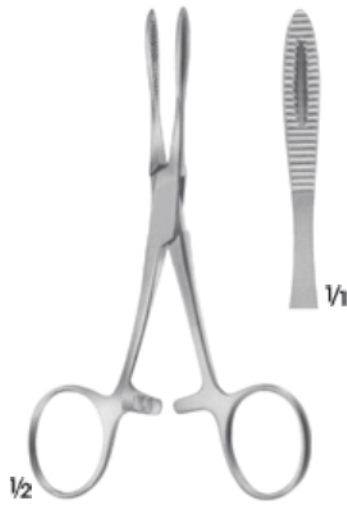

1/2

KRÖNLEIN
45-473
13 cm

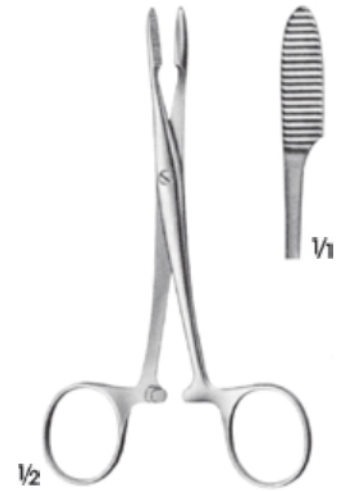

1/2

PEAN
45-474
12.5 cm

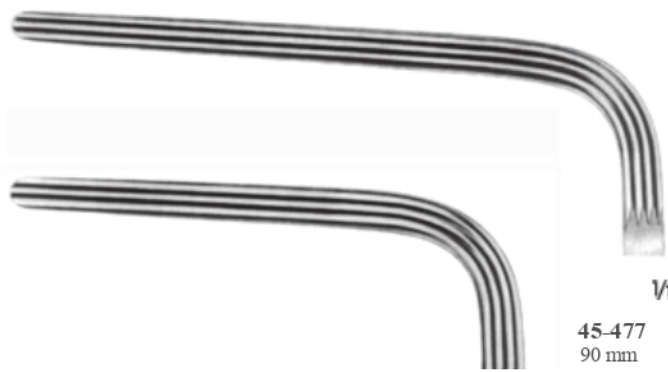

$\frac{1}{2}$
45-477
90 mm

$\frac{1}{2}$
45-476
80 mm



$\frac{1}{2}$



$\frac{1}{2}$

WERTHEIM-CULLEN
45-475
21.5 cm



$\frac{1}{2}$

23 cm



ASCLASS

ASCLASS CERRAHİ ALETLER İMALAT SAN. VE TİC. LTD.ŞTİ

 [asclasscerrahialetler.ve.medya](https://www.instagram.com/asclasscerrahialetler.ve.medya)  [Asclass cerrahi aletler](https://www.facebook.com/Asclasscerrahi.aletler)  www.asclassgrup.com  info@asclassgrup.com - asclassmedya@gmail.com

 Çatalarmut Mahallesi Sezgin Sokak No:7 Kat:1/2/3 İlkadım/SAMSUN